

User's Guide

for Topload Washers

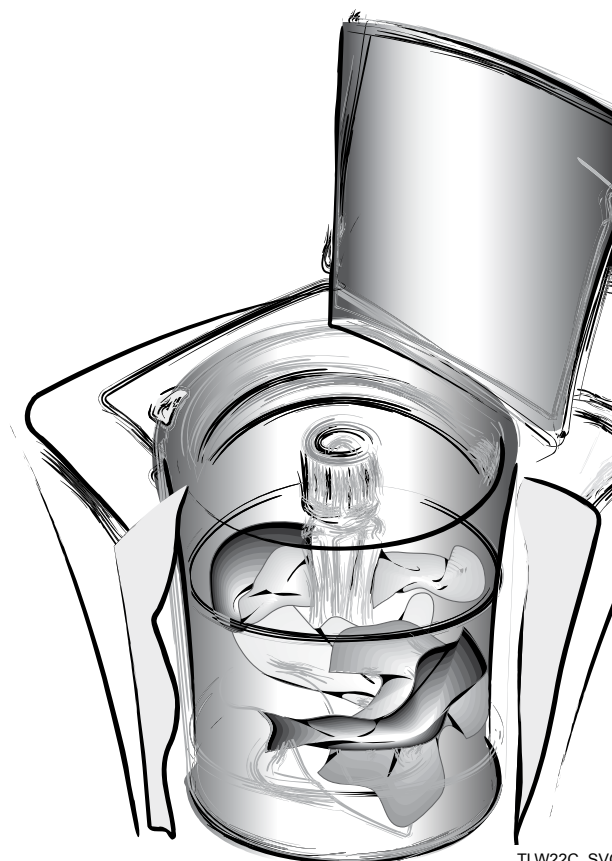

TLW22C_SVG

Original Instructions

Keep These Instructions for Future Reference.

(If this machine changes ownership, this manual must accompany machine.)



www.alliancelaundry.com

Part No. 203061R3
September 2016



WARNING

Failure to install, maintain, and/or operate this machine according to the manufacturer's instructions may result in conditions which can produce bodily injury and/or property damage.

W030



WARNING

For your safety and to reduce the risk of fire or an explosion, do not store or use gasoline or other flammable vapors and liquids in the vicinity of this or any other appliance.

W022

NOTE: The **WARNING** and **IMPORTANT** instructions appearing in this manual are not meant to cover all possible conditions and situations that may occur. It must be understood that common sense, caution, and carefulness are factors which cannot be built into these washers. These factors **MUST BE** supplied by the person(s) installing, maintaining, or operating the washer.

Always contact the distributor, service agent, or the manufacturer about any problems or conditions you do not understand.



Read all instructions before using washer.

This product uses FreeRTOS V7.2.0 (www.freertos.org).

Table of Contents

| | |
|---|-----------|
| Safety Information..... | 5 |
| Explanation of Safety Messages..... | 5 |
| Important Safety Instructions..... | 5 |
| Operation..... | 7 |
| Before Washing..... | 7 |
| Loading the Washer..... | 7 |
| Control Panel..... | 10 |
| Digital Display..... | 10 |
| Cycles..... | 10 |
| Selections..... | 11 |
| Options..... | 11 |
| Status..... | 12 |
| To Wash Clothes..... | 12 |
| Manual Soaking..... | 13 |
| Cycle Operation..... | 14 |
| Optional Features..... | 15 |
| Clothing Care..... | 17 |
| Clothing Concerns..... | 17 |
| Maintenance..... | 19 |
| Cold Weather Care..... | 19 |
| Care of Your Washer..... | 19 |
| Replacing Hoses..... | 19 |
| Filter Screens..... | 19 |
| Vacations and Extended Non-Use..... | 19 |
| Preventative Maintenance..... | 19 |
| Reinstallation of Shipping Materials..... | 19 |
| Motor Overload Protector..... | 20 |
| Troubleshooting..... | 21 |
| Contact Information..... | 24 |

© Copyright 2016, Alliance Laundry Systems LLC

All rights reserved. No part of the contents of this book may be reproduced or transmitted in any form or by any means without the expressed written consent of the publisher.

Safety Information

Explanation of Safety Messages

Precautionary statements (“DANGER,” “WARNING,” and “CAUTION”), followed by specific instructions, are found in this manual and on machine decals. These precautions are intended for the personal safety of the operator, user, servicer, and those maintaining the machine.

| | |
|---|---------------|
|  | DANGER |
| Indicates an imminently hazardous situation that, if not avoided, will cause severe personal injury or death. | |

| | |
|--|----------------|
|  | WARNING |
| Indicates a hazardous situation that, if not avoided, could cause severe personal injury or death. | |

| | |
|---|----------------|
|  | CAUTION |
| Indicates a hazardous situation that, if not avoided, may cause minor or moderate personal injury or property damage. | |

Additional precautionary statements (“IMPORTANT” and “NOTE”) are followed by specific instructions.

IMPORTANT: The word “IMPORTANT” is used to inform the reader of specific procedures where minor machine damage will occur if the procedure is not followed.

NOTE: The word “NOTE” is used to communicate installation, operation, maintenance or servicing information that is important but not hazard related.

Important Safety Instructions

Save These Instructions

| | |
|--|----------------|
|  | WARNING |
| To reduce the risk of fire, electric shock, serious injury or death to persons when using your washer, follow these basic precautions: | |
| W023 | |

- Read all instructions before using the washer.
- Install the washer according to the INSTALLATION INSTRUCTIONS. Refer to the EARTH/GROUND INSTRUCTIONS in the INSTALLATION manual for the proper earth/ground connection of the washer. All connections for water, drain, electrical power and earth/ground must comply with local codes and be made by licensed personnel when required. Do not do it yourself.
- Do not install or store the washer where it will be exposed to water and/or weather.
- Do not add the following substances or textiles containing traces of the following substances to the wash water: gasoline, kerosene, waxes, cooking oils, vegetable oils, machine oils, dry-cleaning solvents, flammable chemicals, thinners or other flammable or explosive substances. These substances give off vapors that could ignite, explode or cause the fabric to catch on fire by itself.
- Under certain conditions, hydrogen gas may be produced in a hot water system that has not been used for two weeks or more. HYDROGEN GAS IS EXPLOSIVE. If the hot water system has not been used for such a period, before using a washing machine or combination washer-dryer, turn on all hot water taps and let the water flow from each for several minutes. This will release any accumulated hydrogen gas. THE GAS IS FLAMMABLE, DO NOT SMOKE OR USE AN OPEN FLAME DURING THIS TIME.
- To reduce the risk of an electric shock or fire, DO NOT use an extension cord or an adapter to connect the washer to the electrical power source.
- Do not allow children to play on or in the washer. Close supervision of children is necessary when the washer is used near children. This appliance is not intended for use by persons (including children) with reduced physical, sensory or mental capabilities, or lack of experience and knowledge, unless they have been given supervision or instruction concerning the use of the appliance by a person responsible for their safety. This is a safety rule for all appliances.
- Cleaning and user maintenance shall not be made by children without supervision.
- Children less than three years should be kept away unless continuously supervised.

Safety Information

- Do not reach into the washer if the washtub or agitator, if applicable, is moving.
- Never operate the washer with any guards, panels and/or parts removed or broken. DO NOT tamper with the controls or bypass any safety devices.
- Use your washer only for its intended purpose, washing clothes. Always follow the fabric care instructions supplied by the garment manufacturer.
- Always read and follow manufacturer's instructions on packages of laundry and cleaning aids. To reduce the risk of poisoning or chemical burns, keep them out of the reach of children at all times (preferably in a locked cabinet). Heed all warnings or precautions.
- Do not use fabric softeners or products to eliminate static unless recommended by the manufacturer of the fabric softener or product.
- Lid MUST BE CLOSED any time the washer is to agitate or spin. DO NOT bypass the lid switch to permit the washer to agitate or spin with the lid open. A brake will stop the washtub within seconds if the lid is opened during spinning. If the washtub does not stop when the lid is opened, remove the washer from use and call the service person.
- Be sure water connections have a shut-off valve and that fill hose connections are tight. CLOSE the shut-off valves at the end of each wash day.
- Keep your washer in good condition. Bumping or dropping the washer can damage safety features. If this occurs, have your washer checked by a qualified service person.
- Do not repair or replace any part of the washer, or attempt any servicing unless specifically recommended in the user-maintenance instructions or in published user-repair instructions that you understand and have the skills to carry out. ALWAYS disconnect the washer from electrical supply before attempting any service.
- Disconnect the power cord by grasping the plug, not the cord. If the supply cord is damaged, it must be replaced by the manufacturer, its service agent or similarly qualified persons in order to avoid a hazard.
- Before the washer is removed from service or discarded, remove the lid or door to the washing compartment.
- Failure to install, maintain, and/or operate this washer according to the manufacturer's instructions may result in conditions which can produce bodily injury and/or property damage.

NOTE: The WARNING and IMPORTANT SAFETY INSTRUCTIONS appearing in this manual are not meant to cover all possible conditions and situations that may occur. Observe and be aware of other labels and precautions that are located on the machine. They are intended to provide instruction for safe use of the machine. Common sense, caution and care must be exercised when installing, maintaining, or operating the washer.

Always contact your dealer, distributor, service agent or the manufacturer about any problems or conditions you do not understand.

Operation

Before Washing

Prepare Wash Load

Empty Pockets and Cuffs

Make sure all pockets are empty and turn them inside out. One bobby pin, metal or plastic toy, nail or sharp object in a load can catch laundry, cause tears and plug the pump. Facial tissue left in a pocket will produce extreme "lint". A crayon or lipstick in a wash load may cause stains that cannot be removed. Roll down cuffs and shake out grass, sand and gravel.

Strings on clothing such as hooded sweatshirts may get caught in or around the agitator. Remove the strings if possible or tie them together.



TLW1990N_SVG

Mend Rips and Tears

Little holes can become bigger in the washer. Mend holes and tears before placing garments in the washer.

Close Zipper and Fasten Hooks

These can catch on garments in a wash load and tear them. Tie belts and sashes so they won't wind around clothes.

Check For Colorfastness

Squeeze a portion of garment in warm or hot sudsy water. If the color bleeds or runs, wash the item separately in cold water.

Sort Items

Different items use different wash cycles and temperatures. Always follow the manufacturer's care label.



TLW1991N_SVG

Proper sorting is easy if you follow a few guidelines:

1. **Sort by Color:** Separate items into loads of whites, darks, lights and non-colorfast.
2. **Sort by Fabric and Construction:** Separate items into loads of cottons/linens, permanent press, synthetics/blends/poly knits, and delicates.
3. **Sort by Temperature:** Separate items into loads that can be washed in cold, warm or hot water.
4. **Sort by Type and Amount of Soil:** Heavily soiled clothes will need extra treatment. Lightly soiled clothes can become dingy if washed with heavily soiled items.
5. **Sort Lint "Shedders" From Lint "Receivers":** Some fabrics attract lint and should not be washed with lint-shedding loads. Lint shedders are cottons, terry towels, chenille bedspreads, rugs and clothes that have been heavily bleached. Lint receivers are synthetics, permanent or durable press, knits (including socks), corduroy, and other smooth fabrics.

Pretreat

Pretreat shirt collars and cuffs with a pretreat product or liquid detergent when placing them in the washer. Before washing, treat special stains individually.

| | |
|--|----------------|
| | WARNING |
| Do not wash or dry items soiled with vegetable or cooking oils. Some oils may remain after washing and may cause the fabric to catch on fire by itself. | |
| W527 | |

Loading the Washer

Load Articles

NOTE: Always add detergent first.

Operation

- Load items by the amount of space they take up, not by their weight. Mix large and small items in a load to get the best washing results.
- Drop items loosely into the washtub. The bulk of the clothes rather than the weight will determine load size. Do not pack items in or wrap them around the agitator. Overloading can cause poor cleaning, excessive wrinkling and tears.

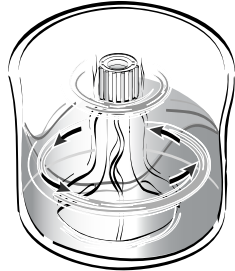

TLW1992N_SVG

- Items should move freely through the wash water for best cleaning results. Items should rollover, sink and then reappear.
- When washing very large items, do not fill washtub as full as with other loads.

Load Size (Water Level)

- The water level in your washer should fit the size of your wash load. Small loads will use lower water levels. There must be enough water in the washtub to allow items to move and turn over freely.

Wrong Water Level for Size of Load



TLW2223N_SVG

Right Water Level for Size of Load

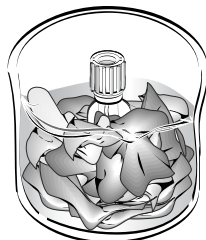

TLW2224N_SVG

- Overloading the washtub can result in poor washing and rinsing.
- Overloading may also cause wrinkling and tearing of items as well as increased wear to the washer's motor.

IMPORTANT: If in doubt, always use a larger load size. Most average loads will require the Large Load Size setting. Failure to have the correct volume of water relative to the load may decrease washer performance.

| Load Sizes | |
|-------------|---|
| Small | 1-2 permanent press dress shirts or 2 pillow cases or 1 lightweight dress or similar size load |
| Medium | 3-4 permanent press dress shirts or 1 twin sheet, 1 pillow case or 1-2 lightweight dresses |
| Large | 6-7 permanent press shirts or 2 twin sheets, 2 pillow cases or 8 standard bath towels, 6 wash cloths |
| Extra Large | 8-9 shirts, 5 pair polyester pants or 2 queen size sheets, 4 pillow cases, 2 nightgowns, 1 pair men's pajamas or 1 queen size bedspread |

Wash Temperature

Hot

Hot water is the most effective for cleaning, but it is not recommended for all fabric types (read labels).

Warm

The Warm Wash is useful for providing a thorough cleaning on light and moderately soiled clothing without damaging fabric or adding to color fading. Warm water also reduces wrinkling. Use with non-colorfast or dark colors, permanent press, silks, woolens, nylon, and acrylic.

Cool

The Cool Wash temperature is useful for washing permanent press fabrics.

Cold

The Cold Wash is ideal for delicate items. Although its cleaning abilities are not as great as with hot or warm water, it is useful for colors that bleed easily and for sensitive fabrics.

All rinses use cold water. It is the most beneficial for fabrics. Cold rinses reduce wrinkling and color fading. In addition, cold rinses will save money and energy.

NOTE: In wash temperatures colder than 16°C [60°F], detergents do not dissolve well. This may cause ineffective cleaning, or lint and residue to form.

NOTE: Always follow manufacturer's care labels.

Wash Temperature Guide

| Water Temperature | Use | Comments |
|-------------------|--|---|
| HOT | <ul style="list-style-type: none"> Sturdy whites and colorfast items Work clothes Soiled items Nappies | <ul style="list-style-type: none"> Best cleaning for items soiled with oily or greasy stains, grass, or ink. |
| WARM | <ul style="list-style-type: none"> Light and moderately soiled items Non-colorfast or dark colors Permanent press Silks, woolens, nylon, acrylic | <ul style="list-style-type: none"> Reduces wrinkling in permanent press fabrics Less fading Reduces shrinking in knits |
| COOL | <ul style="list-style-type: none"> Permanent press Silks, woolens, nylon, acrylic | <ul style="list-style-type: none"> Less fading Reduces shrinking in knits |
| COLD | <ul style="list-style-type: none"> Non-colorfast fabrics Extra delicate clothing | <ul style="list-style-type: none"> Saves energy Reduces color fading Reduces wrinkling Reduces shrinking |

Energy

You can save energy when washing by following a few guidelines:

1. Heating water accounts for the greatest energy expense when washing. Save on heating water by using warm or cold washes.
2. Wash full loads, but do not overload.
3. Use Soak option for heavily soiled items to reduce the need for higher soil level selections.

Control Panel

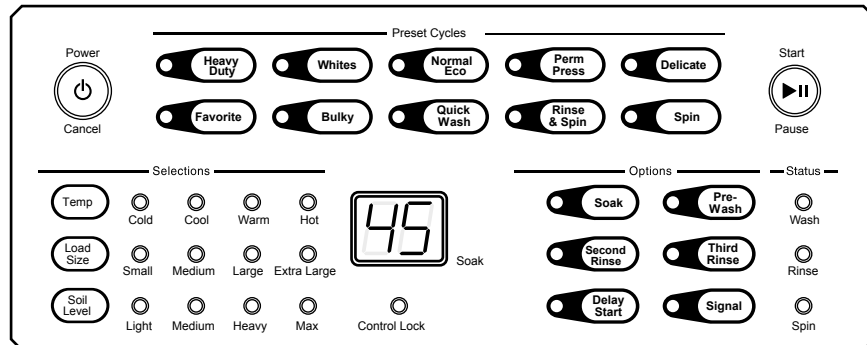

TLW2225N_SVG

Digital Display

The two-digit display is used to show the time remaining in a cycle.

If the cycle time is over 99 minutes the control will display either 1H, 2H, etc., and then the additional minutes over one or two hours.

When the control is powered off, the right-most decimal in the display will flash every one to five minutes to indicate that the machine is in Idle Mode.

The display also shows diagnostic codes.

Soak

In the lower right of the display, a single light will flash during any soak portion of the cycle.

The soak light also will flash once every one to five minutes in Idle Mode. Idle Mode is entered if no keypads have been pressed for five minutes after a cycle is finished. Press the Power/Cancel keypad to exit this mode and power the display for cycle/option selection. This light will flash again after five minutes when it re-enters Idle Mode.

Cycles

The following cycle descriptions will help determine which cycle to choose depending on the type of laundry being washed. The descriptions are standard settings that may be modified using the Selections and Options.

The last cycle that is set, including selections and options, is saved even if the control is turned off.

NOTE: The cycle used for a normally soiled cotton load at the rated load capacity 8.5 kg is as follows:

- Normal Eco Cycle
- Warm wash water temperature setting
- Extra Large Load Size
- Medium Soil Level

Heavy Duty

Use for sturdy items, like play or work clothes, towels, T-shirts, etc. The wash time selection will depend on the type of fabric and the amount of soil. For the best results when cleaning heavily soiled items, use a higher soil level selection. Lightly soiled items require less wash time.

Use the Prewash setting for extra heavily soiled items. During the PREWASH setting, the washtub will fill with water, agitate for a reduced period of time and spin out.

Whites

This cycle is designed to keep white laundry white. It utilizes a longer wash time.

Normal Eco

This cycle uses a spray rinse to reduce water consumption. It also uses less hot water. This cycle is recommended for washing everyday cottons and linens. If using fabric softener in this cycle, select the Second Rinse option.

Perm Press

Use for permanent press items and synthetics. The final spin is a low spin speed.

Delicate

Wash delicate items usually washed by hand on this cycle. A full tub of water is recommended (even for small loads) to allow the delicate items to move freely through the water. More water helps reduce fabric wear, wrinkling, and provides for a clean wash.

On this cycle, the agitation during the wash portion of the cycle is not constant. The wash will alternate between periods of agitation and then a short soak until advancing to the spin portion of the cycle. All spin speeds are a low spin.

Favorite

The Favorite cycle keypad allows the user to save different cycles, selections and options for later use. Nine favorite cycles can be saved.

1. Press the Favorite keypad. The control will display the cycle and modifier settings for the first Favorite cycle. The 2-digit display will switch between F1 and the cycle time for the selected cycle.
2. Press the keypads for the desired cycle, selection and option settings.
3. Press the Favorite, Start/Pause or Delay Start keypad to save the current settings.
4. Press the Power/Cancel keypad to discard the current settings.
5. The next Favorite cycle, F2, will be displayed.

Bulky

Use this cycle when washing bulky items such as blankets and comforters. The cycle includes a gentle wash action and longer wash time to thoroughly clean larger items.

Quick Wash

Wash lightly soiled items on this cycle. The cycle includes a shorter wash time.

Rinse & Spin

Use to quickly rinse items. The rinse is followed by a high spin.

Spin

Use this cycle to extract water from wet items. The cycle uses the high spin.

Selections

The following selections can be used to modify the currently chosen cycle. The default selections will be lit after choosing a cycle.

Temp

Press the Temp keypad to change the cycle's wash water temperature from the default selection to Cold, Cool, Warm, or Hot.

Load Size

The Load Size Selection determines the amount of water used in the cycle.

Choose Small, Medium, Large or Extra Large according to the amount of laundry being washed.

Soil Level

Changing the Soil Level keypad will add more wash time to the cycle.

Choose Light, Medium, Heavy or Max according to the amount of soil in the laundry load.

Options

The following options can be used to modify the currently chosen cycle, signal volume and control lock.

Soak

The Soak option adds a 27 minute soak to the beginning of the cycle. Use for heavily soiled or stained clothing. The washtub will fill with water, agitate for a reduced period of time, pause for approximately 27 minutes, and spin out to complete the cycle.

Pre-Wash

The Pre-Wash option adds a second wash to the selected cycle.

Second Rinse

This Option will provide an additional rinse to the selected cycle. The water temperature will be cold.

Third Rinse

The Third Rinse Option provides two rinses in addition to the selected cycle. It is useful for detergent sensitive skin, allergies, etc. The water temperature will be cold.

NOTE: If Second Rinse and Third Rinse are both selected, the cycle will provide three additional rinses for a total of four rinses.

Delay Start

Pressing the Delay Start Option will allow the cycle to begin up to 24 hours after pressing the keypad. Pressing it once will delay the cycle by one hour and 1h will show on the control's display. Press the Delay Start keypad again to increase the time by one hour each press. Press the Start/Pause keypad to begin the countdown.

While setting the Delay Start Option, the cycle time and the Delay Start keypad light will flash (1 second on/off).

After the Delay Start Option is started, the Delay Start keypad light will flash (1 second on/off).

Signal

Pressing the Signal keypad will change the end of cycle signal volume. There are four settings: Off, Low, Medium, High.

Control Lock (Secure keypad)

Pressing and holding the Signal keypad for three seconds will turn on the Control Lock. The Control Lock status light will be lit. While Control Lock is on, no other keypad presses are allowed. Press and hold the Signal keypad again to turn the option off.

Status

The Status lights are lit during the cycle to show what part of the cycle is running.

| | |
|-------|---|
| Wash | The Wash status light is lit during the wash portion of the cycle including Pre-Wash and Soak, if selected. |
| Rinse | The Rinse status light is lit during the rinse portions of the cycle including Second Rinse and Third Rinse, if selected. |
| Spin | The Spin status light is lit during the final spin portion of the cycle. |

To Wash Clothes

IMPORTANT: Before using your new washer, make sure the washer cord is connected to an appropriate electrical outlet that is properly installed and connected to a protective earth/ground. Make sure the washer hoses are connected to the hot and cold water taps, and that the taps are turned on. Be sure the drain hose is not kinked and is inserted into a drain. Refer to the INSTALLATION INSTRUCTIONS for details of proper washer installation.

IMPORTANT: Prior to first wash, use an all purpose cleaner, or a detergent and water solution, and a damp cloth to remove shipping dust from inside of wash drum.

1. Get the clothes ready for washing. Empty pockets and cuffs. Sort items into separate loads. Pretreat stains and heavily soiled areas.



IMPORTANT: Remove all sharp objects from laundry to avoid tears and rips to items during normal machine operation.

2. Measure and add low sudsing, High Efficiency (HE) detergent to the washtub. Follow instructions on detergent package for amount to use.



NOTE: High efficiency (HE) detergent is recommended for use in this machine. Look for the HE logo or “high efficiency” on the detergent’s label.

3. Add clothes loosely into the washtub. Maximum dry clothes load is 8.5 kg [18.7 pounds] based on energy efficiency and electrical safety tests performed to Australia/New Zealand safety standard for Washing Machines.



4. Close the lid. The washer will not fill, agitate or spin with the lid open.

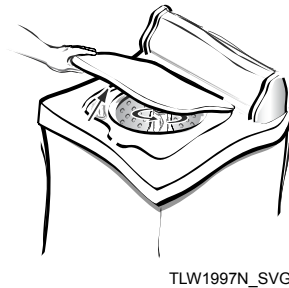

WARNING

To reduce the risk of serious injury, do not by-pass the lid switch to permit the washer to agitate or spin with the lid open.

W898

5. If not already on (control lights will be lit), turn on the washer. Press the Power button to turn on the washer.

NOTE: You will not be able to press the Start/ Pause button to start a cycle until five seconds after turning on the washer. A status light will flash during this warm-up period.

6. Select the cycle according to the type of fabric being washed. If the selected cycle is not the correct cycle for the fabric being washed, you may change the cycle selection at any time until the first wash fill is complete.

NOTE: The Normal Eco cycle is recommended for everyday cottons and linens.

7. If desired change the Selections and Options settings.
8. Press the Start/Pause button to begin the cycle.

NOTE: Lid must be closed for fill, agitation and spin to start.

The washer will stop (pause) shortly before the wash and rinse spins. They are a normal part of the cycle.

Manual Soaking

Do not fill the washer and open the lid or press the Start/Pause button to perform a soak cycle. Use the Soak option on the control panel to perform this operation.

Cycle Operation

The cycles of your washer include several different stages. Refer to the tables below for what can be expected during the cycles that you select.

The cycle stages are dependent on the cycle, selections and options chosen.

The times listed are approximate and will vary depending on the selections and options chosen.

Cycle stages that are Options must be selected on the keypad to be included in the cycle.

NOTE: The rinse water temperature will be cold, including when optional rinses are selected.

| Normal Eco Cycle | | | | |
|-------------------------|--|----------------|------------------------|----------|
| Cycle Stage | Activity | Time (minutes) | Speed | Comments |
| Soak | Fill/Agitate/Soak/Drain/Spin | 39:00 | Low Agitate; High Spin | Option |
| Pre-Wash | Fill/Agitate/Drain/Spin | 15:10 | High | Option |
| Wash | Fill/Spin-Spray/Agitate/Soak/Agitate/Soak/Agitate/Soak/Agitate/Soak/Drain/Spin-Spray | 158:31 | High Agitate; Low Spin | |
| Rinse | Spin-Spray | 3:57 | Low | |
| Second Rinse | Fill/Agitate/Drain/Spin | 12:10 | High | Option |
| Third Rinse | Fill/Agitate/Drain/Spin | 24:20 | High | Option |
| Final Spin | Spin | 7:00 | High | |
| Total (without Options) | | 2:49:28 | | |

| Delicate Cycle | | | | |
|-------------------------|--|----------------|------------------------|----------|
| Cycle Stage | Activity | Time (minutes) | Speed | Comments |
| Soak | Fill/Agitate/Soak/Drain/Spin | 39:00 | Low Agitate; High Spin | Option |
| Pre-Wash | Fill/Agitate/Drain/Spin | 15:10 | Low | Option |
| Wash | Fill/Agitate/Soak/Agitate/Soak/Agitate/Soak/Drain/Spin-Spray | 15:35 | Low | |
| Rinse | Fill/Agitate/Drain/Spin | 12:10 | Low | |
| Second Rinse | Fill/Agitate/Drain/Spin | 12:10 | Low | Option |
| Third Rinse | Fill/Agitate/Drain/Spin | 24:20 | Low | Option |
| Final Spin | Spin | 5:00 | Low | |
| Total (without Options) | | 32:45 | | |

| All Other Cycles | | | | |
|-------------------------|-------------------------------|---|---|----------|
| Cycle Stage | Activity | Time (minutes) | Speed | Comments |
| Soak | Fill/Agitate/Soak/Drain/Spin | 39:00 | Agitate = Low Spin = Low (Perm Press); High (all others) | Option |
| Pre-Wash | Fill/Agitate/Drain/Spin | 15:10 | Agitate = Low (Bulky); High (all others) Spin = Low (Perm Press); High (all others) | Option |
| Wash | Fill/Agitate/Drain/Spin-Spray | Heavy Duty = 17:45 Whites = 19:45 Perm Press = 15:45 Quick Wash = 14:45 Bulky = 19:45 | Agitate = Low (Bulky); High (all others) Spin = Low | |
| Rinse | Fill/Agitate/Drain/Spin | 12:10 | Agitate = Low (Bulky); High (all others) Spin = Low (Perm Press); High (all others) | |
| Second Rinse | Fill/Agitate/Drain/Spin | 12:10 | Agitate = Low (Bulky); High (all others) Spin = Low (Perm Press); High (all others) | Option |
| Third Rinse | Fill/Agitate/Drain/Spin | 24:20 | Agitate = Low (Bulky); High (all others) Agitate = Spin = Low (Perm Press); High (all others) | Option |
| Final Spin | Spin | 5:00 | Low (Perm Press); High (all others) | |
| Total (without Options) | | Heavy Duty = 34:55 Whites = 36:55 Perm Press = 32:55 Quick Wash = 31:55 Bulky = 36:45 | | |

Optional Features

Bleach Dispenser

The bleach dispenser is located in the left front corner, under the lid.

Use liquid bleach in the dispenser. Powdered bleach must not be used in the dispenser. Add powdered bleach to the wash water.

Use no more than one cup chlorine bleach for large loads, three-quarters cup for medium and one-half cup for small loads.

Carefully pour recommended amount of bleach into the dispenser during the first fill of the washer.

Be careful not to spill undiluted bleach. It is a strong chemical and can damage some fabrics if it is not properly diluted.

Fabric Softener Dispenser

Fabric softener should not be used when the Normal Eco cycle is selected unless the Second Rinse option is also selected.

To Use Dispenser

After the clothes are loaded into the washtub and before the start of the WASH cycle, pour the proper amount of liquid fabric softener into the bottle measuring cap (refer to bottle directions). Pour into dispenser.

The large fabric softener dispenser allows for the fabric softener to be diluted with water. We recommend adding water up to the fill level. Do not exceed tip of arrow which indicates correct fill level. Overfilling can allow fabric softener to spill onto the clothes, causing stains on clothes if the softener comes into contact with detergent suds.

Setting the water level to medium or higher will result in better performance from the fabric softener.

The fabric softener will remain in the dispenser during the wash fill, agitation and spin. At the end of the wash spin, the liquid fabric softener will be dispensed into the washtub through the slots in the agitator and will be mixed with the incoming rinse water.

To Clean the Dispenser

1. Remove the dispenser housing from agitator by squeezing the lower part of the dispenser, pulling directly upward and at the same time tilting slightly. This will expose the dispenser cup, which is also removable for cleaning. Refer to illustration.
2. Soak both housing and cup in hot soapy water.
3. Rinse housing and cup clean.
4. Clean funnel shape in top of agitator by using a small brush.
5. After cleaning, install dispenser cup, then push dispenser housing directly downward onto top of agitator until firmly snapped together.

IMPORTANT: When adding detergent to the wash load, **DO NOT** allow any detergent to enter the softener dispenser cup. If this happens, refer to the cleaning instructions.

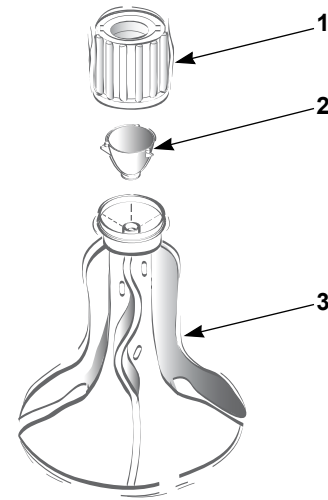

TLW2001N_SVG

1. Dispenser Housing
2. Dispenser Cup
3. Agitator

Use Tips

- Fabric softener spilled onto garments may cause staining. To remove, dampen stain and rub with bar soap. Wash as usual.
- Liquid fabric softeners will be dispensed during the first rinse and should not be combined with bleach, bluing, starch, detergents, soaps or packaged water conditioners.
- Fabric softener is not to be used in dispenser when using Pre-wash cycle, if available.
- When adding detergent to wash water, do not allow any to enter into softener dispenser cup, as softener will become gummy.

To prevent softener buildup, the dispenser can be filled with clean water for automatic cleaning. This can be done in washing cycles other than when softener is used.

Clothing Care

Clothing Concerns

To keep clothes looking white or bright, use good washing practices at all times to prevent a gradual build-up of soil or water hardness minerals on them. If you notice that your clothes are not as bright as they should be, take corrective measures immediately.

| Problem | Cause | Solution |
|----------------------------|--|--|
| Gray or Dingy Clothes | Insufficient Detergent | Add more detergent to washtub before loading clothes. Mild detergents are not suitable for average soil. |
| | Improper Sorting | Wash whites separately. Separate light from heavily soiled items. Clothes can pick up soil from dirty wash water. |
| | Nonphosphate Detergent and Hard Water | Follow package directions. Soften water if possible. |
| | Water Not Hot Enough | White clothes will stay whiter with hot wash water. Increase temperature. |
| | Overcrowding Washer | Clothes must circulate freely through the water for best results. |
| Yellowed Clothes | Unremoved Soil | Skin soil is hard to remove. Check hem edge of sheets and pillowcases, bottom end of t-shirts, etc. If this portion is white and center is yellow, the fabric contains unremoved soil. Use sufficient detergent and a hot wash. Chlorine bleach may be needed. |
| | Clothes Stained from Iron in the Water | To test for an iron stain, use a rust remover that is recommended for use with washing machines on a portion of the garment. Follow bottle directions for larger items. |
| | Older Clothes | Some white fabrics turn yellow with age and cannot be whitened. |
| Clothes Tearing or Damaged | Improper Use of Chlorine Bleach | No correction for bleach damaged clothes. Always measure and dilute bleach. Take extra care to avoid unwanted spilling. |
| | Insufficient Pre-care | Fasten all hooks and zippers. Mend tears. Remove objects from pockets. |
| | Overcrowding or Overloading | Make sure all items can move freely during agitation. |

Table continues...

Clothing Care

| Problem | Cause | Solution |
|----------------|--|--|
| Excessive Lint | Improper Sorting | Fabrics that shed lint cannot be washed with fabrics that receive lint. |
| | Insufficient Detergent/Non-phosphate Detergent | Use enough detergent so lint remains suspended in water and flushed out. Do not oversuds the water. |
| | Mixing Fabric Types | Knits and permanent press attract lint. Wash these only with similar items. Use fabric softener in rinse water. |
| Wrinkling | Improper Sorting | Heavy items like towels should not be washed with light items like nightgowns. |
| | Improper Cycle | Make sure cycle selected is appropriate for type of clothes. |
| | Improper Temperature | Using a warm or cold wash and a cold rinse reduces wrinkling. |
| | Too Many Clothes in Washer | Clothes must circulate freely through the water for best results. |

Maintenance

Cold Weather Care

If the unit is delivered on a cold day (below freezing), or is stored in an unheated room or area during the cold months, do not attempt to operate the washer until it has had a chance to warm up. Water from the previous cycle may remain.

Care of Your Washer

Use only a damp or sudsy cloth for cleaning the control panel. Some cleaning products may harm the finish on the control panel or damage the interior. DO NOT use products that contain alcohol on the control panel. Wipe the panel dry after cleaning.

Wipe the washer cabinet as needed. If detergent, bleach or other washing products are spilled on the cabinet, wipe immediately. Some products will cause permanent damage if spilled on the cabinet.

Do not use scouring pads or abrasive cleansers.

The washtub will need no particular care though it may need rinsing or wiping after some unusual loads have been washed. This also may be necessary if too little detergent has been used.

Leave the lid open to allow the inside of the washer to dry out after use. This helps prevent musty odors from developing.

The agitator should not be removed except for service. The washtub is designed to be self cleaning.

Replacing Hoses

Hoses and other natural rubber parts deteriorate after extended use. Hoses may develop cracks, blisters or material wear from the temperature and constant high pressure they are subjected to.

All hoses should be checked on a monthly basis for any visible signs of deterioration. Any hose showing the signs of deterioration listed above should be replaced immediately. All hoses should be replaced every five years.

Filter Screens

Check the filter screens in the fill hoses for debris or damage every six months. Clean or replace them if necessary.

If the washer is filling with water slower than normal, check the filter screens. Clean or replace them if necessary.

Order filter screen Part No. 803615 from the nearest authorized parts distributor.

Vacations and Extended Non-Use

IMPORTANT: To avoid possible property damage due to flooding, turn off the water supply to the washer whenever there will be an extended period of non-use.

Preventative Maintenance

Follow these guidelines to ensure the washer operates properly. Call for service if you observe any of the following: water of any amount on the floor; an increase in operating noise or water remaining in the wash basket after a cycle.

| Frequency | Maintenance Procedure |
|------------------|---|
| Monthly | <ol style="list-style-type: none"> 1. Check all hoses and the drain for leaks. 2. Check the lid switch for proper operation. 3. Check to make sure the washer is level. 4. Clean upper 2-3 inches of wash tub. Fill washer with warm water at highest setting. Use an all-purpose cleaner or a steel wool soap pad. |
| Every six months | <ol style="list-style-type: none"> 1. Clean the filter screens in the fill hoses. |
| Every five years | <ol style="list-style-type: none"> 1. Have a qualified service technician conduct general preventative maintenance on the washer to ensure it operates properly. 2. Replace the fill hoses. |

Reinstallation of Shipping Materials

You must install the shipping brace and shipping plug any time the washer is moved.

Shipping Brace

The shipping brace in the lid opening should be saved and reinstalled whenever the washer is moved. To reinstall the brace, open the washer lid and place the brace over the washer agitator, placing the back of the brace into the lid opening first.

Shipping Plug

The plastic shipping plug should be saved and reinstalled any time the washer is moved. The plug fits into two openings: The base opening and the shipping plug opening on the bottom of the movable pivot dome. The plug **MUST** be inserted into both openings to prevent damage to the washer. In order to accomplish this, the shipping plug opening must be directly lined up with the base opening.

Refer to illustration below.

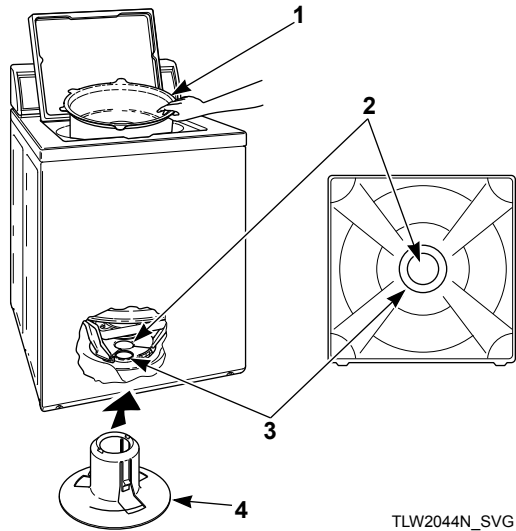

1. Shipping Brace
2. Shipping Plug Opening
3. Base Opening
4. Shipping Plug

After the shipping brace has been installed in the lid opening, tilt washer back enough to access base opening.

Insert shipping plug into base opening and, using the palm of your hand, push shipping plug into washer until it snaps into shipping plug opening.

Motor Overload Protector

The internal motor overload protector will stop the motor automatically if there are too many clothes in the washtub or if a failure has occurred within the machine's motor. The control's digital display will show **EP**. The overload protector will reset itself and the display will then show **EP**, **SE** alternately. Remove any laundry wrapped around the agitator. Press the Start/Pause button to resume the cycle. If the overload protector stops the motor again, remove the washer from use and call a service person to correct the problem.

Troubleshooting

Try these troubleshooting tips before making a service call. They may save you time and money.

| Washer Symptom | Possible Cause/Solution |
|----------------|---|
| Won't Fill | <ul style="list-style-type: none"> • Make sure power cord is plugged all the way into the electrical outlet. • Make sure hot and cold water taps are turned on. • Make sure lid is closed. • Make sure that the fill hoses are not kinked or twisted. • Press Start/Pause button to start washer. • Make sure that the controls are properly set. • In the Normal Eco cycle, during the rinse portion of the cycle, the tub won't fill with water. Instead, there is a spray rinse. • Make sure that the last spin has been completed. • Check the laundry room fuse or circuit breaker. • Clean the screens in the water mixing valve and the filter screens located at the tap end of the fill hoses. (Owner is responsible for service calls regarding cleaning of the screens.) • Water is being siphoned from the washer during the cycle. Refer to the Installation instructions to make sure that the drain hose has been properly installed. |
| Won't Start | <ul style="list-style-type: none"> • Make sure lid is closed. • Press Start/Pause button to start washer. • Make sure power cord is plugged all the way into the electrical outlet. • Make sure that the controls are properly set. • Check the laundry room fuse or circuit breaker. • The motor overload protector may have stopped the cycle. It will reset itself and the display will show LP, SE. Press the Start/Pause button to resume cycle. • You will not be able to press the Start/ Pause button to start a cycle until five seconds after turning on the washer. A status light will flash during this warm-up period. |
| Won't Agitate | <ul style="list-style-type: none"> • Make sure lid is closed. • Press Start/Pause button to start washer. • Make sure power cord is plugged all the way into the electrical outlet. • Check the laundry room fuse or circuit breaker. • The motor overload protector may have stopped the cycle. It will reset itself and the display will show LP, SE. Press the Start/Pause button to resume cycle. • Broken drive belt. Call the service person. |

Table continues...

| Washer Symptom | Possible Cause/Solution |
|---------------------------|---|
| Won't Spin | <ul style="list-style-type: none"> • Make sure lid is closed. • Press Start/Pause button to start washer. • Make sure power cord is plugged all the way into the electrical outlet. • Check the laundry room fuse or circuit breaker. • The motor overload protector may have stopped the cycle. It will reset itself and the display will show EP, SE. Press the Start/Pause button to resume cycle. • Broken drive belt. Call the service person. |
| Stops/Pauses During Cycle | <ul style="list-style-type: none"> • Pauses are part of the washer's normal operation. The washer will stop (pause) shortly before the wash and rinse spins. • Check the laundry room fuse or circuit breaker. • The motor overload protector may have stopped the cycle. It will reset itself and the display will show EP, SE. Press the Start/Pause button to resume cycle. |
| Won't Drain | <ul style="list-style-type: none"> • Make sure drain hose is not kinked or twisted. • Make sure drain hose is not clogged. • Make sure drain receptacle is not clogged. • Refer to the Installation instructions to make sure that the drain hose has been properly installed. |
| Water Leaks | <ul style="list-style-type: none"> • Check that fill hoses are properly installed on the taps and the washer's water mixing valve. • Check the condition of the fill hoses. Replace fill hoses every five years. • Make sure drain receptacle is not clogged. • Check laundry room plumbing. • Check house water pressure. In cases of extremely low water pressure, leaking may occur. • Laundry load may be oversudsing or overloaded. Use less detergent (or low-sudsing detergent) and proper load sizes. |
| Is Noisy | <ul style="list-style-type: none"> • Wash load may be unbalanced. Open lid and redistribute the load. • Make sure washer is level. Uneven leveling can cause vibration. • A newly installed washer may make a knocking sound if the machine has been in storage. The belt may have settled. Run washer through 4-5 cycles to loosen belt. Washer operation will not be affected. |
| Load Is Too Wet | <ul style="list-style-type: none"> • Wash load may be unbalanced. Open lid and redistribute the load. • Load is too small. Add items to make full load. |

Table continues...

| Washer Symptom | Possible Cause/Solution |
|----------------------------------|---|
| Wrong Water Temperature | <ul style="list-style-type: none"> • Make sure that the controls are properly set. • Check fill hoses. Make sure hot tap hose is connected to hot mixing valve (indicated with "H" on the valve bracket) and cold tap is connected to cold mixing valve (indicated with "C" on the valve bracket). • Make sure laundry room water heater is adjusted properly. • The Normal Eco cycle uses a colder water temperature. |
| LP on digital display | <ul style="list-style-type: none"> • If the motor overload protector has stopped the cycle, the control will display LP. It will reset itself and the display will show LP, SE. Press the Start/Pause button to resume cycle. • This condition could be due to an overloaded washtub. Be sure to review proper load sizes in the Loading The Washer Section. |
| Er, FL on digital display | <ul style="list-style-type: none"> • This code will appear if the washer has not reached the fill level after 30 minutes during a wash or rinse fill. • Make sure hot and cold water taps are turned on. • Make sure that the fill hoses are not kinked or twisted. • Clean the screens in the water mixing valve and the filter screens located at the tap end of the fill hoses. • Unplug the machine for 15 seconds to clear this code. |
| OF, SE on digital display | <ul style="list-style-type: none"> • This code indicates the washtub has filled to the overflow level. • After pressing Start/Pause button the machine will begin to spin to attempt to pump water out. • If Start/Pause button is not pressed within five minutes, Er, OF will be displayed and the machine will need to be unplugged for 15 seconds to clear the code. |
| Er, dr on digital display | <ul style="list-style-type: none"> • This code indicates that water is still in the washer at the end of the cycle. • Check the drain hose and drain receptacle to make sure they are installed properly and not blocked. • Unplug the machine for 15 seconds to clear this code. |
| Er, PS on digital display | <ul style="list-style-type: none"> • The control has detected trouble sensing the water fill level. • Unplug the machine and call for service. |
| Other Er Codes | <ul style="list-style-type: none"> • If the control displays any other Er codes, unplug the machine for 15 seconds. Plug the machine back in. If code still appears, call for service. |

Contact Information

If service is required, contact the nearest Factory Authorized Service Center.

If you are unable to locate an authorized service center or are unsatisfied with the service performed on your unit, contact:

Alliance Laundry Systems
Shepard Street
P.O. Box 990
Ripon, Wisconsin 54971-0990
www.alliancelandry.com
Phone: (920)748-3121, Ripon, Wisconsin
+32 56 41 20 54 Wevelgem, Belgium

Date Purchased _____

Model Number _____

Serial Number _____

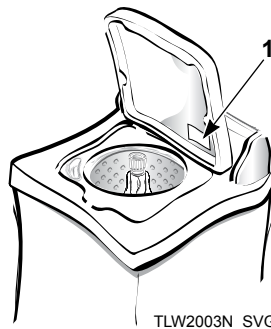

1. Serial Plate

When contacting us about your washer, PLEASE GIVE THE MODEL AND SERIAL NUMBERS. The model and serial numbers are located on the serial plate. The serial plate will be in the location shown. Please include a copy of your bill of sale and any service receipts you have.

If replacement parts are required, contact the source from where you purchased your washer or call +1 (920) 748-3950 or +32 56 41 20 54 for the name and address of the nearest authorized parts distributor.

| | |
|--|----------------|
| | WARNING |
| To reduce the risk of serious injury or death, DO NOT repair or replace any part of the unit or attempt any servicing unless specifically recommended in the user-maintenance instructions or in published user-repair instructions that you understand and have the skills to carry out. | |
| W329 | |